

VIBRA SCREW, INC.

BULK BAG UNLOADERS



World Leader in vibration technology



Vibra Screw® Inc.

BULK BAG UNLOADERS

The Vibra Screw Bulk Bag Unloader provides a safe, dust-free and convenient way to handle and discharge bulk bag. It is available in several configurations to accommodate all styles of bags and all discharge requirements.

With models, options and accessories, Vibra Screw offers choices from a simple unit to complete systems.

A simple Bulk Bag Unloader includes a receiving hopper and frame for customer-supported bags. A complete bag handling system might include integral bag hoist and trolley and all necessary material-handling accessory equipment.

The Vibra Screw Bulk Bag Unloader makes handling of bulk bags finally practical by:

- Providing an easy and safe method to lift, support and discharge bulk bags.
- Eliminating dust and spillage associated with other methods of bag handling.
- Permitting controlled, regulated discharge with a variety of feed devices and weighing options.



Model 1-VHD

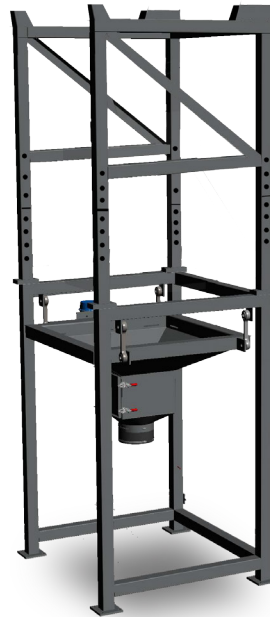

Model 2-VHD with adjustable bag support frame



Model 2-VHD with integral hoist & trolley



Model 2-VHD Bulk Bag Unloader with Live Bottom Bin surge bin and Heavy Duty Screw Feeder



Multiple ingredient batch and feed systems

Choose from a Broad Range of Models and Features
Design your Vibra Screw Bulk Bag Unloader installation to suit your particular needs



Model 2-VHD
 Full Bulk Bag support from Integral "I" beam with Hoist & Trolley.

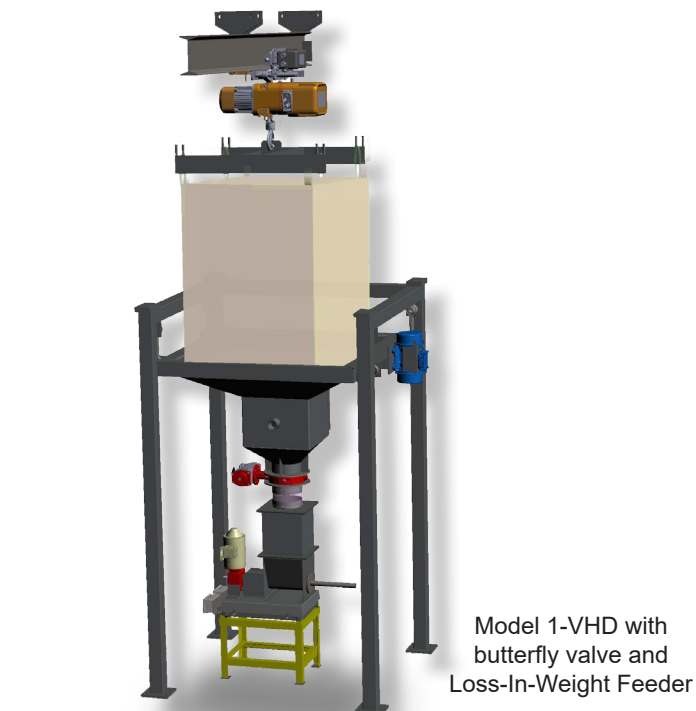
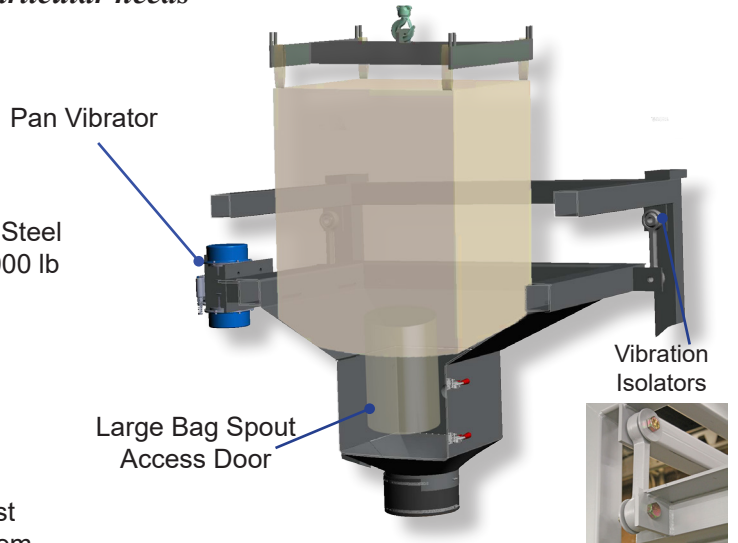

Model 2-VHD Fork-Lift Bag Rack
 An efficient fork lift compatible, bag lifting adapter and integral support frame allow operators to utilize lift trucks to place bags into position on the discharge hopper. Specify an adjustable height frame, and you can change the working height up to thirty percent, an important feature for variable size bags

BULK BAG UNLOADER OPTIONS and FEATURES

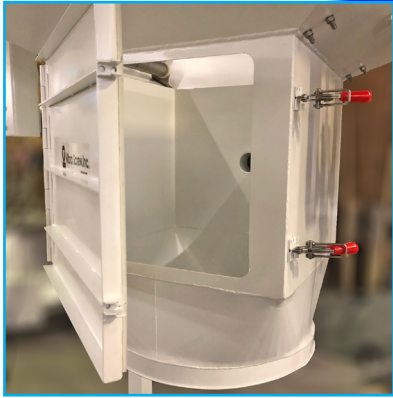

Bag Spout Access Door

18" x 20" access door with quick clamps.
Two door access is also available
as an option

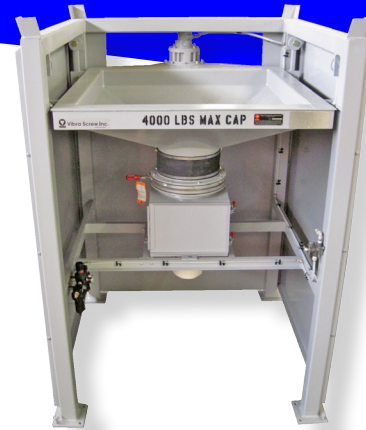

Support Frame Enclosure

Fully enclosed Bulk Bag Support Frame
(optional)

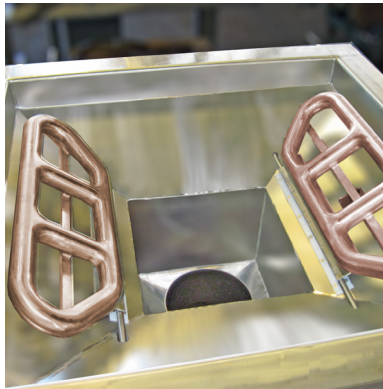

Massaging Paddles

Bulk Bag Massaging paddles (bar type) pneumatically operated, using two air cylinders. Provides a means to condition the bag to enhance material flow out of the bag. Air operated, air set, filter regulator, solenoid valves operated by two timers for on/off operation

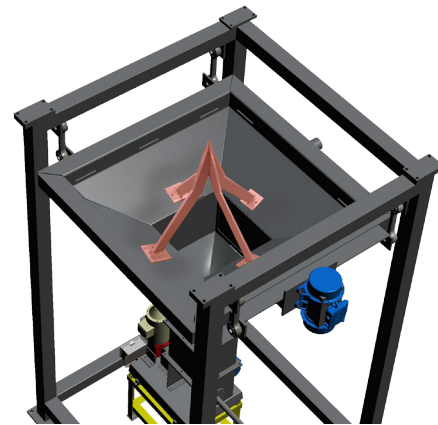

Bag Slitter

Designed for one way bags that have no outlet. Used only with vibrated hopper bottom to assure maximum material flow.



Paper Bag Dump Station

Paper Bag Dump station mounted under the outlet of a Bulk Bag Unloader allows minor ingredient to be added to the same flow stream as the material from the Bulk Bag.



Material Surge Bins

Live Bottom Bin can be mounted integral to the Bulk Bag Unloader frame in sizes from 5 to 100 cubic ft capacity. Assures down stream equipment will not run out of material during bag change over.

BULK BAG UNLOADER OPTIONS and FEATURES

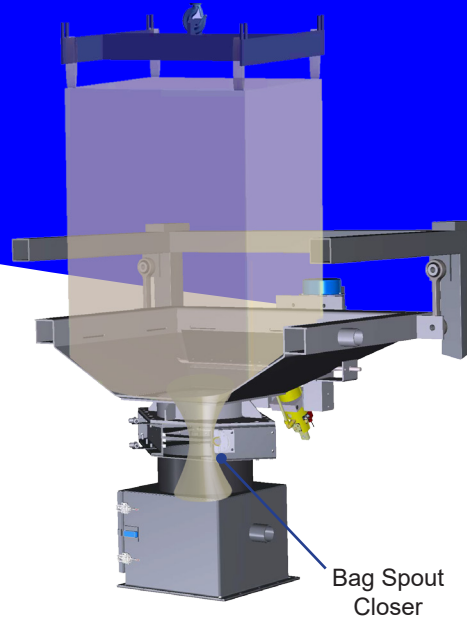
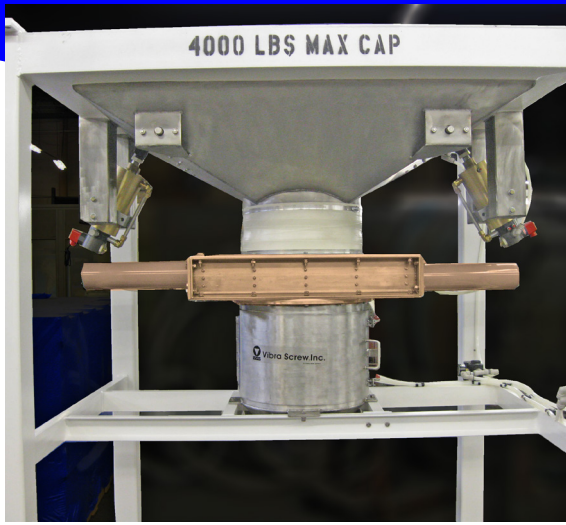

Bag Spout Closer Pinch Valve

Pneumatic Bulk Bag outlet spout closer, This option provides a means to seal the bag off and re-tie or to simply stop flow of material to the process. The valve is actuated with two pneumatic cylinders that move the v-formed plates toward each other. This bunches and pinches the bag off at the bag outlet spout. The pinch plates are made from stainless steel. This valve is operated automatically or manually as necessary for the specific application. Requires air set with lubricator, two way solenoid valve by customer.

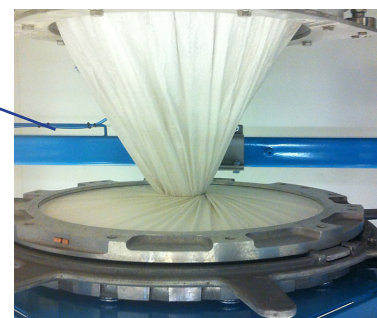
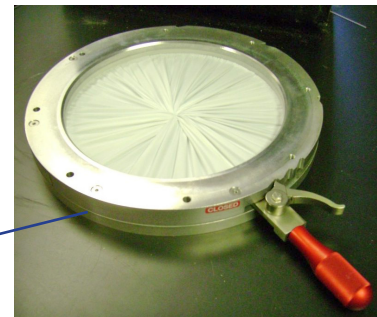
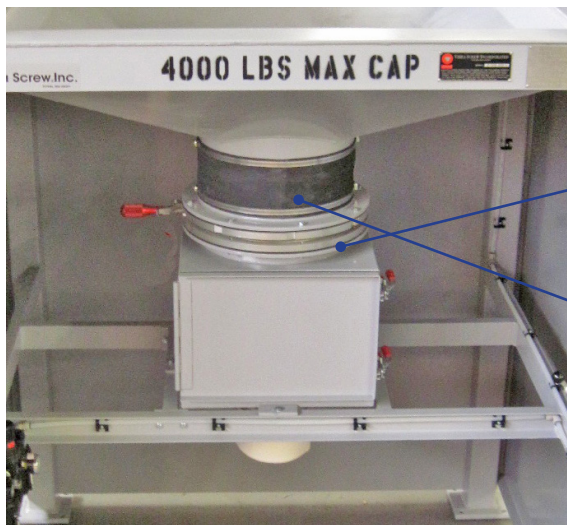

Bag Spout Closer IRIS Valve (Manual)

This option provides a means to seal the bag off and re-tie the bag spout. Not recommended for heavy density materials.

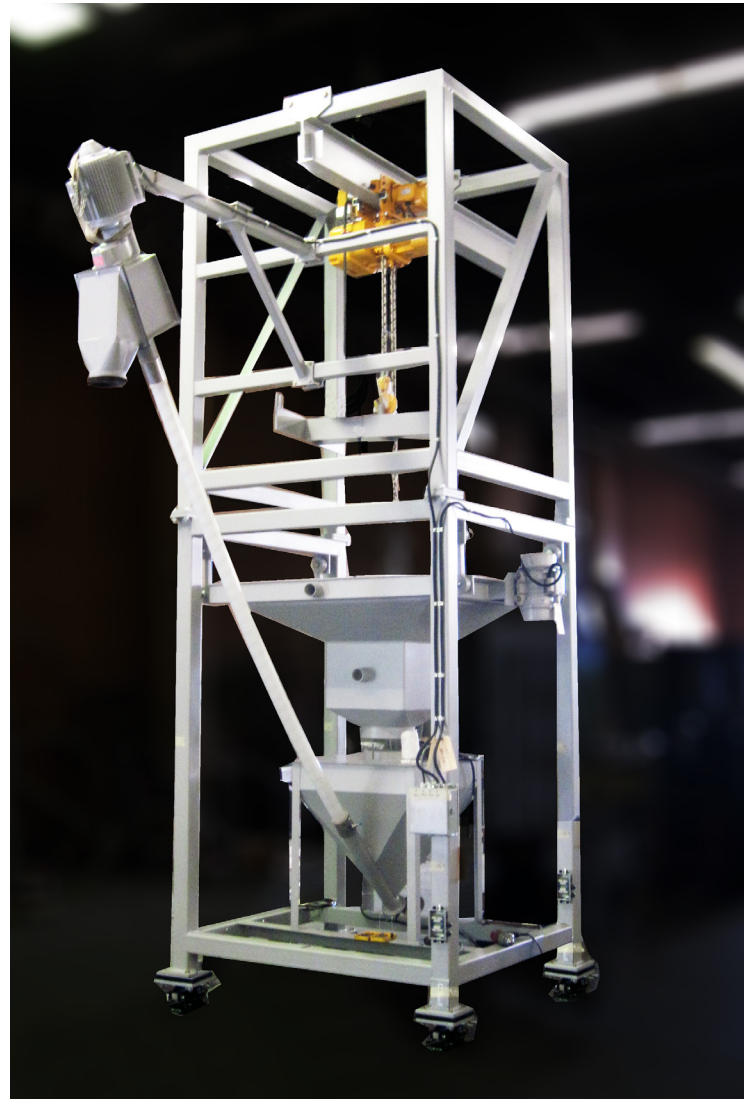
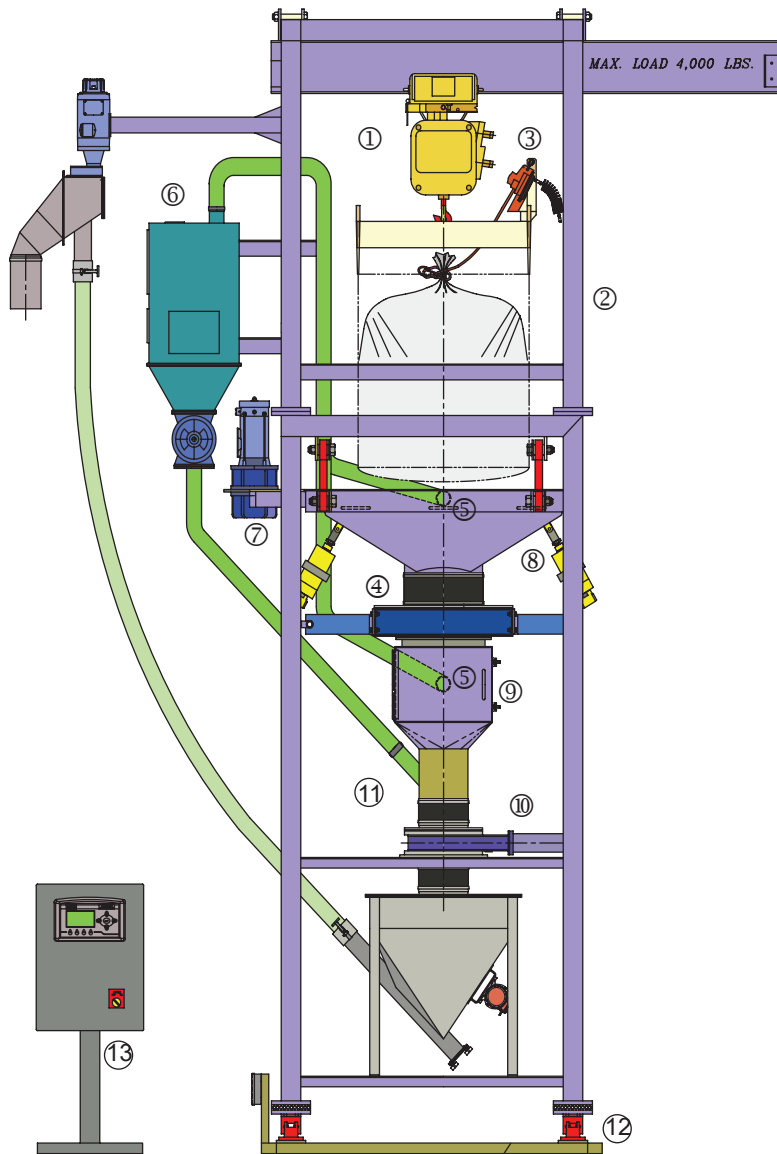

Complete System packages including Bulk Bag Unloaders, vibrated bins, paper bag dump station, Loss-In-Weight continuous and batching systems, and pneumatic conveying systems.

1. Hoist with I-BEAM
2. Heavy Duty Steel Frame - fixed or adjustable
3. Bag Line Tensioner (optional)
4. Pneumatic Knife Gate Bag Closure (optional)
5. Dust Collection Ports
6. Dust Collection System (optional)
7. Vibration Discharge System
8. Flow Stimulator Paddle Type (optional)
9. Access Box with Large Door
10. Pneumatic Slide Gate Valve
11. Connector to Feeder, Conveyor or any down stream Device (optional)
12. Load Cell (optional)
13. Loss-In-Weight Batch Controls (optional)

THE VIBRA SCREW GUARANTEE

If your Vibra Screw equipment doesn't perform in the service for which it was sold, we'll refund your money. Ask any other equipment manufacturer to put that in writing.

No time limits. No conditions.

Keeping Dry Materials Moving

With a wealth of knowledge and experience in the use of controlled vibration to process dry bulk materials, Vibra Screw engineers have devised systems to handle most materials --- probably your material included.

As the leader in dry solids processing, our name is recognized and trusted worldwide in such diverse industries as:

- **FOOD**
- **MINING**
- **CHEMICAL**
- **STEEL**
- **FOREST PRODUCTS**
- **PLASTICS**
- **ENVIRONMENTAL CONTROL**
- **ORDNANCE**
- **AGRICULTURE**
- **PHARMACEUTICALS**



Vibra Screw® Inc.

VIBRA SCREW INC.

755 Union Blvd , Totowa, NJ 07512

Ph: 973-256-7410 Fax: 973-256-2114

www.vibrascrew.com